

# Absolute Tracker solutions

Explore our full range of laser tracker systems, from portable and large volume to automated and high volume.





From Hexagon's advanced understanding of manufacturing

---

comes a range of laser trackers, scanners, software and accessories





Developed over 200 years  
of technical innovation

---

to deliver practical productivity  
and quality gains for manufacturers  
across all of industry



# Key performance principles



## Accuracy

Exceptional precision, ensuring trustworthy data for critical applications.

- ✓ **Absolute Encoders**  
Angular accuracy with no referencing required
- ✓ **Precise distance measurement**  
Advanced technologies like AIFM, ADM, WFD and the TruePoint Interferometer
- ✓ **Gravity orientation**  
1 arcsecond levelling precision
- ✓ **Certifications**  
ISO and ASTM Certified



## Reliability

Consistent, dependable performance in tough environments with minimised downtime.

- ✓ **Robust construction**  
IP54-certified for water and dust protection
- ✓ **Thermal stability**  
Wide temperature range
- ✓ **Guaranteed service**  
24-month warranty and 10 years' guaranteed serviceability

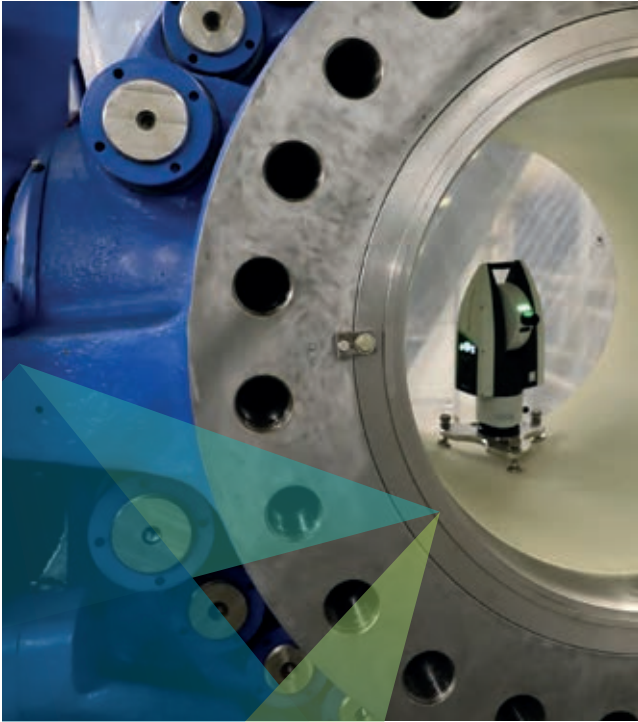

## Portability

Unmatched mobility for precise measurements wherever needed.

- ✓ **Compact**  
Lightweight and easy to transport
- ✓ **Battery-powered**  
No need for external power
- ✓ **Wireless connectivity**  
Cable-free operation
- ✓ **Flexible mounting**  
Including lightweight carbon fibre tripods.
- ✓ **Storage and transport**  
The complete system fits in one flight case



## Productivity

Ease-of-use and streamlined workflows for faster inspection and maximum efficiency.

- ✓ **Widerange of accessories**  
Including probes, scanners, and reflectors
- ✓ **Automation-ready**  
Integrates with robots, rails and AMRs
- ✓ **Effortless operation**  
Intuitive interfaces and software-agnostic integrations
- ✓ **PowerLock technology**  
Maintains tracking after line-of-sight interruptions



## Why Absolute Trackers

# Improved quality in manufacturing

## The industries that rely on Absolute Tracker-powered metrology

- ✓ Aerospace
- ✓ Automotive
- ✓ Energy and power generation
- ✓ Industrial equipment
- ✓ General manufacturing
- ✓ Education and research
- ✓ Defence
- ✓ Rail
- ✓ Marine
- ✓ Construction
- ✓ Heavy machinery
- ✓ Agriculture
- ✓ Motorsport
- ✓ Robotics
- ✓ Medical



Why Absolute Trackers?

# More applications than ever

Technology designed to meet your manufacturing challenges



- ✓ Build and inspect jig and fixtures
- ✓ Metrology assisted assembly
- ✓ Sheet metal inspection
- ✓ Mould and die
- ✓ Additive manufacturing
- ✓ Machine and robot calibration
- ✓ On-machine verification
- ✓ Composite part inspection
- ✓ In-process checks
- ✓ Virtual assembly
- ✓ Real-time machine path correction
- ✓ Maintenance and repair
- ✓ Reverse engineering
- ✓ Flush and gap
- ✓ BIW inspection
- ✓ Precise marking operations
- ✓ Completeness checks
- ✓ Metrology assisted construction
- ✓ Hot-part inspection
- ✓ Precision mirror alignment



# Discover the world's best laser trackers

Hexagon's Absolute Trackers are built on patented and industry leading technologies like the Absolute Interferometer, the Absolute Distance Meter, direct scanning, PowerLock, SHINE scanning, MeteoStation monitoring and high-definition cameras.

## They deliver unmatched:





✓ Accuracy   ✓ Portability   ✓ Reliability   ✓ Productivity

For every medium-to-large-scale manufacturing application, there's an Absolute Tracker solution that can deliver greater productivity and a better final product.

**With an Absolute Tracker, precision meets practicality at the pinnacle of portable high-grade metrology.**



# Contents

<b>Introduction</b>		
Why Absolute Trackers?	04	
<hr/>		
<b>Hexagon's Absolute Tracker range</b>		
<hr/>		
	<b>Leica Absolute Tracker AT960</b>	
	AT960	12
	AS1 and AS1-XL scanners	14
	Leica T-Probe	16
	Automation	18
<hr/>		
	<b>Leica Absolute Tracker AT930</b>	
	AT930	20
<hr/>		
	<b>Leica Absolute Tracker AT500</b>	
	AT500	22
	B-Probe <sup>plus</sup>	24
<hr/>		
	<b>Direct Scanning Absolute Trackers</b>	
	ATS800	26
	ATS600	28
	Automation	30
<hr/>		
<b>Add-ons</b>		
Accessories and reflectors	32	
<hr/>		
<b>Software</b>		
Digital platform solutions	34	
<hr/>		
<b>Your tracker</b>		
Which Absolute Tracker is right for you?	36	
<hr/>		
<b>Certificates</b>		
ISO certifications	38	
<hr/>		
<b>Technical details</b>		
Specifications	40	
<hr/>		
<b>Aftercare</b>		
Service and support	44	
<hr/>		
<b>Next steps</b>		
Contact us	48	

# An Absolute Tracker for every application

Hexagon's Absolute Tracker range:

## 6DoF and 3D Absolute Trackers

The Absolute Tracker range is designed for practical manufacturing needs, delivering high-accuracy measurements with efficiency and reliability.

Built with automation in mind, every model supports streamlined workflows, while select trackers are optimised for advanced automation setups to tackle the most demanding industrial challenges.

### AT960 **Leica Absolute Tracker AT960**

The flagship of the Absolute Tracker range, offering full 6DoF measuring functionality. Capable of powering both manual and automated inspection and production systems, compatible with portable probe and scanning devices

### AT930 **Leica Absolute Tracker AT930**

Our premium 3D tracker, for high-accuracy reflector measurements that can support a range of applications.

### AT500 **Leica Absolute Tracker AT500**

An ultra-long-range tracker designed for measurement anywhere and best-in-class usability.



## Direct scanning Absolute Trackers

Combine reflector measurement and cutting-edge scanning capabilities, enabling fast, precise inspections without contact.

Engineered for automation and efficiency, these trackers excel in complex, large-scale applications, helping manufacturers boost productivity and maintain precision.

### **ATS800** Leica Absolute Tracker ATS800

Our premium direct scanning laser tracker, combining reflector measurements with high-accuracy contactless measurement of features and edges, as well as large surfaces, from up to 40 metres.

### **ATS600** Leica Absolute Tracker ATS600

Our first direct scanning laser tracker, combining reflector measurements with metrology-grade contactless measurement of surfaces from up to 60 metres.



Absolute Tracker range

# Leica Absolute Tracker AT960

## The flagship 6DoF tracker

The fully-portable AT960 6DoF laser tracker delivers fast, accurate and versatile measurement, setting a new standard in portable industrial metrology.

It represents a robust, single-unit solution for reflector, probe and non-contact handheld scanner inspection.

From aerospace and automotive to shipbuilding and construction, this easy-to-use system handles even the most complex large-scale metrology tasks, including real-time machine-controlled production.

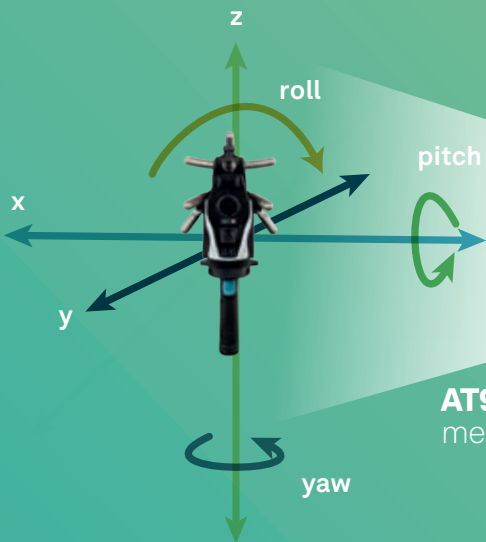

**AT960:** Six degrees of measurement freedom

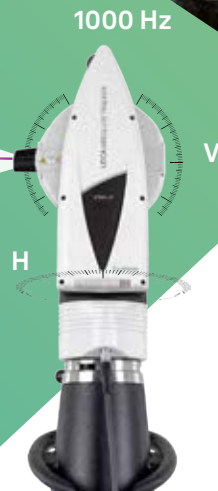

**D:** distance  
**V:** vertical angle  
**H:** horizontal angle

# Leica Absolute Tracker AT960

## Precise

**Exceptional accuracy:** Measures with distance uncertainty of just  $\pm 10$  microns to any sensor, ensuring trusted results for critical applications.

**Advanced zoom technology:** Built-in mini variozoom lenses maintain clear LED target tracking over long distances.

## Versatile and fast

**Long-range capability:** High-accuracy reflector measurements at up to 80 metres for large-scale applications.

**Data collection:** Collects location data at up to 1000 Hertz and supports non-contact scanners registering 1.2 million points per second for rapid inspections.

## Portable

**Wireless:** Compact, battery-powered and wireless design for use anywhere, from shop floors to remote sites.

**Move with you:** Operates in quality rooms, on production lines, or within robotic setups.

## Fully automation-ready

**Automated inspection:** Assembly and production within a robotic setup when paired with sensors such as the AS1 and AS1-XL scanners and the Leica T-Mac.

**Real-time robotic control:** thanks to its 6DoF and 7DoF tracking capabilities

**Flexible and autonomous systems:** Through integration with AGVs, AMRs and dynamic inspection setups.

**Accuracy independent of robotic precision:** Thanks to features like tool changers and wide-angle reflectors that support versatile configurations.



Absolute Tracker range

# Absolute Scanner AS1 and AS1-XL

## Collecting and using 3D point cloud data

Laser scanners work in conjunction with a global referencing system such as a laser tracker or portable measuring arm to create a three-dimensional model of a surface or entire part.

Due to their high data-density—millions of individual data points—these models are typically called ‘point clouds’.

### Compatible with Absolute Arms

AS1 laser scanners are also compatible with Hexagon’s Absolute Arm.

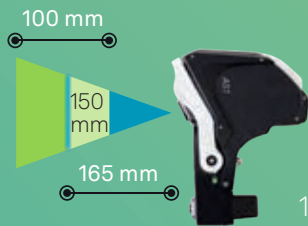

**AS1**  
1.2 million pts/s

Scanline width  
(at standoff)  
600 mm

Standoff 700 mm

Working range 600 mm

**AS1-XL**  
1.2 million pts/s

AS1-XL  
hidden-point  
measurement  
capability =  
depth up to 1 m

# Use with the Leica Absolute Tracker AT960

## AS1 and AS1-XL

### Absolute Scanner AS1

- ✓ High speed scanning
- ✓ Highest accuracy measurement
- ✓ Surface and feature scanning
- ✓ Ability to scan any material with SHINE technology
- ✓ Versatility for handheld and automated inspection and operation with arm or tracker



### Scanning

**A 6DoF system** can be used to provide global positional referencing for an extended sensor system that uses a handheld scanner at the point of measurement.

**This allows** for measurement of hidden points without tracker repositioning as well as the fast collection of point cloud data for complete surface mapping

### Absolute Scanner AS1-XL

- ✓ All the attributes of the AS1 – plus larger scale capability
- ✓ High-quality scan data at very high speed across large surfaces
- ✓ Extra-wide scan line for faster coverage of large surfaces
- ✓ Large standoff for measurement within deep cavities or other hidden areas



### Key capabilities

**Both the AS1 and AS1-XL scanners provide a wider laser scanning stripe for:**

- ✓ Faster part coverage
- ✓ A faster rate of data capture for high-speed scanning
- ✓ A laser concept designed for consistency across various surface types

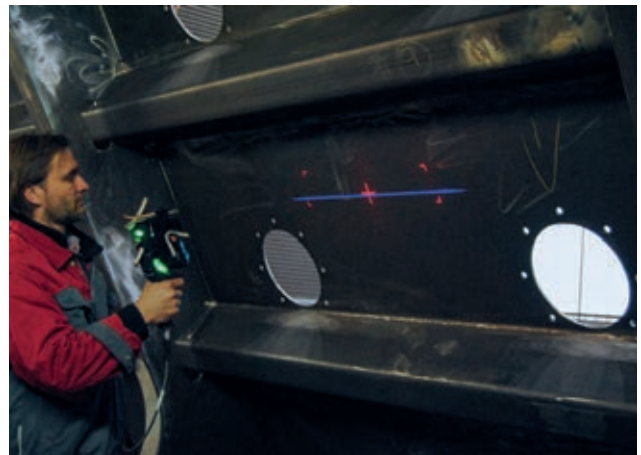

Absolute Tracker range

# Leica T-Probe

## High-accuracy 6DoF probing

The Leica T-Probe is a completely wireless solution for measuring hidden and hard-to-reach points with unmatched accuracy and flexibility.

Paired with the AT960, it delivers fast, precise and efficient single-point data acquisition up to 30m from the Tracker.

Lightweight, battery-powered and cable-free, the T-Probe is the most accurate handheld probe in the world. It's built to give you improved productivity and ease of use in demanding environments.

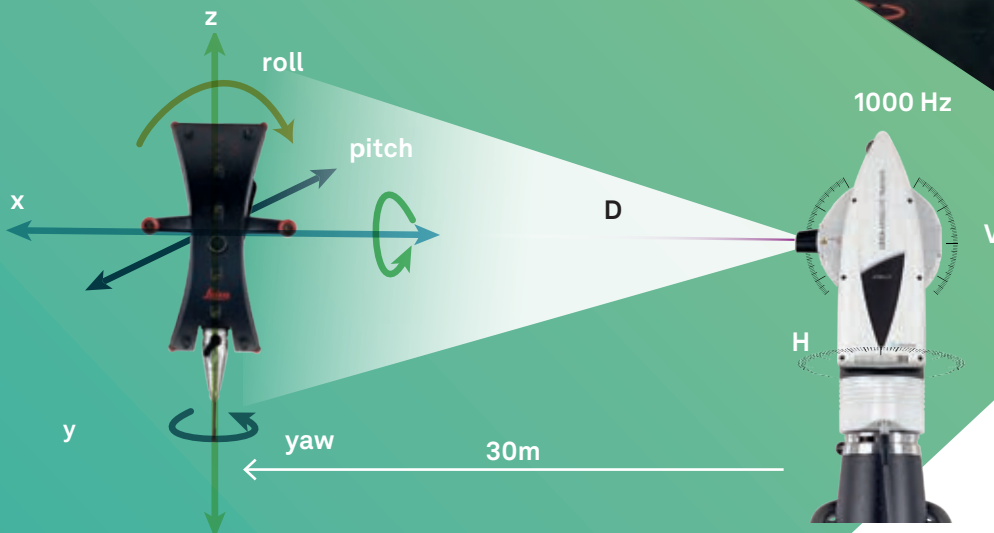

D: distance  
V: vertical angle  
H: horizontal angle

# T-Probe

## Productive

**Hidden-point capability:** Measure concealed areas without relocating the laser tracker, reducing measurement time by up to 80% compared to reflector-based methods.

**Fast setup:** Minimal station changes and automated pairing streamline your workflow.

## Lightweight

**Compact and durable:** Carbon fibre construction keeps the T-Probe lightweight at just 0.64 kilograms.

**Full-day operation:** Long-life battery and wireless design ensure fatigue-free performance for extended use.

## Simple

**User-friendly design:** Assignable multi-function buttons and automatic stylus recognition make operation intuitive and training minimal.

**Precise drilling assistance:** With the punch tool accessory, locate and mark drill positions quickly and accurately.

## Accurate

**Error-free measurement:** Automatic stylus recognition eliminates common manual offset errors.

**Unlimited styli options:** A wide range of styli, tip configurations and optional probe extension accessories support diverse applications, making it ideal for geometric dimensioning and tolerancing.

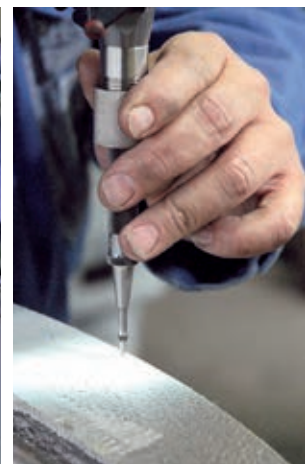

Absolute Tracker range

# Automation

## With the Absolute Tracker AT960

The AT960 integrates seamlessly into automated workflows, offering reliable, high-accuracy solutions for inspection, calibration and robotic control. Whether you're implementing autonomous mobile robots or robotic scanning cells, the AT960 delivers the precision and efficiency you need to optimise your production processes.

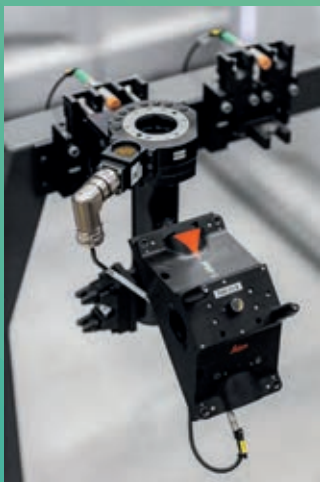

### Leica T-Mac

A 6DoF tracking device specifically designed for automated applications, the Leica T-Mac is a fully robot-mountable positioner. Trackable with a high degree of accuracy at up to 30 metres from the tracker, it is a fundamental component of any 6DoF Absolute Tracker automation system.

# Automation

## Automated part inspection

### Robotic scanning cells

With the AS1 or AS1-XL scanner mounted on a robot, working in conjunction with the AT960, Hexagon's PRESTO Quality Systems is a suite of measurement cells that delivers turnkey automated inspection solutions.



### Autonomous mobile inspection

The AT960, combined with the AS1 or AS1-XL on an Autonomous Mobile Robot (AMR), delivers a fully autonomous and flexible inspection solution.

With Hexagon's Wireless Real-Time Link (WRTL), data is transmitted wirelessly between the tracker and scanners, eliminating cables for seamless and efficient operation.

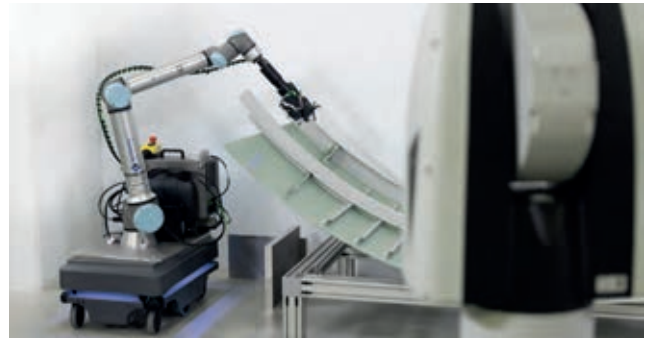

## Robot/machine path correction

### Robot/machine calibration

Pair the AT960 with the Leica T-Mac and Hexagon's RoboDyn software for effortless robot calibration and ISO performance testing.

This powerful combination ensures your robots operate with optimal accuracy, meeting the highest industry standards.



### Realtime robot path correction

Hexagon's Real-Time Feature Pack (RTFP) delivers precise, real-time robotic control using the EtherCAT or Profinet protocol.

A 7DoF system provides precise and accurate control in automated applications involving processes such as machining or part assembly, keeping your operations efficient and error-free.



Absolute Tracker range

# Leica Absolute Tracker AT930

## High-end 3D measurement

The AT930 delivers reliable, high-speed 3D measurement with advanced dynamic capabilities that make it the choice for fast, accurate and user-friendly measurement to reflectors.

Equipped with an Absolute Interferometer, it delivers seamless reflector tracking with automatic target location, real-time architecture and the ability to instantly re-establish interrupted beams, making it a reliable solution for your measurement needs.

The AT930 excels in diverse applications, from confined spaces to large-scale environment and Machine Calibration using the wide-angle Super CatEye Reflector.

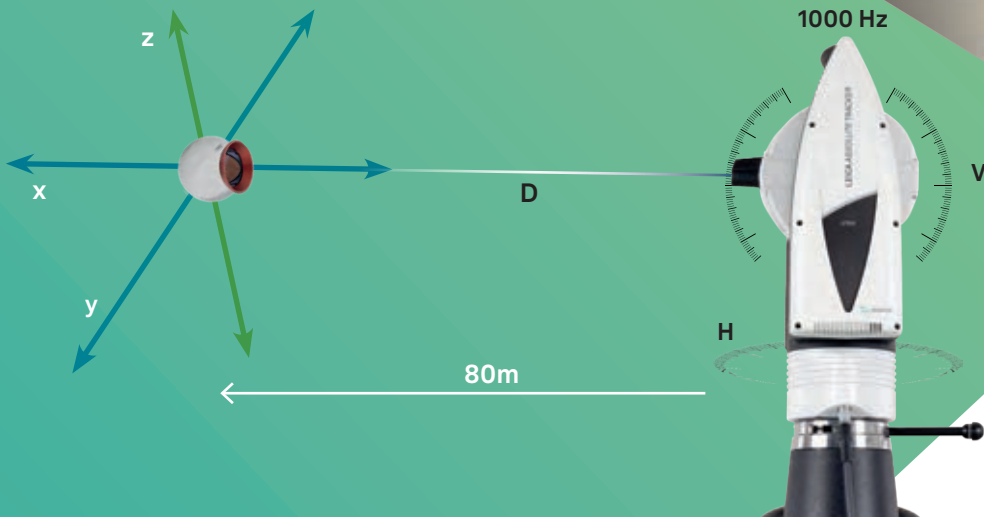

D: distance  
V: vertical angle  
H: horizontal angle

# Leica Absolute Tracker AT930

## Precise

**Versatile range:** Excels in confined spaces with no minimum distance and measures at a range of up to 80 metres.

**High accuracy:** Achieves exact 3D positioning with a tolerance of  $\pm 10$  microns, even in complex geometries

## Productive

**Fast data export:** Captures up to 1,000 points per second with low latency using the optional Real-Time Feature Pack.

**Dynamic tracking:** Enables real-time point tracking for rapid adjustments with reflector mounting.

## Portable

**Rugged design:** IP54-certified construction ensures reliability in tough environments.

**Mobile measurement:** Levelling equipment, wireless communication, choice of mains and battery power.

## Seamless

**Efficient relocation:** 3D reflector technology enables the tracker to be relocated in the same coordinate system, across large areas, maintaining calibration to enhance flexibility and reduce downtime.

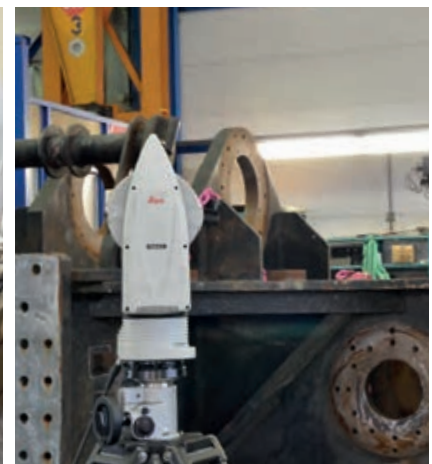
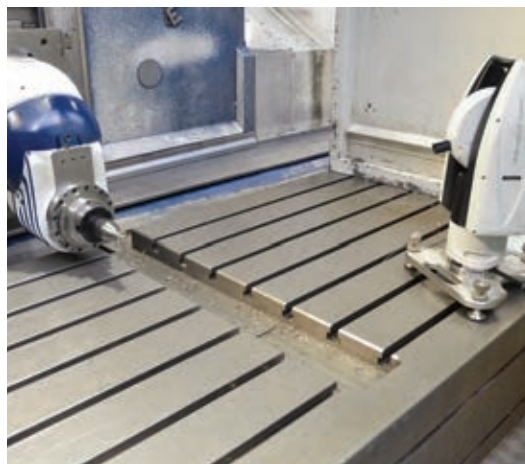

Absolute Tracker range

# Leica Absolute Tracker AT500

Ready to measure anywhere

The Leica Absolute Tracker AT500 is Hexagon's first all-in-one laser tracker, designed for unmatched portability and ease of use.

With its fully battery-powered, integrated-controller design, the AT500 is quick to set up and ready for ultra-long-range reflector measurements. This tracker also offers entry-level 6DoF probing with the optional B-Probe<sup>Plus</sup> add-on.

The AT500's simplicity, robust design, versatility and usability means you can measure anything, anywhere.

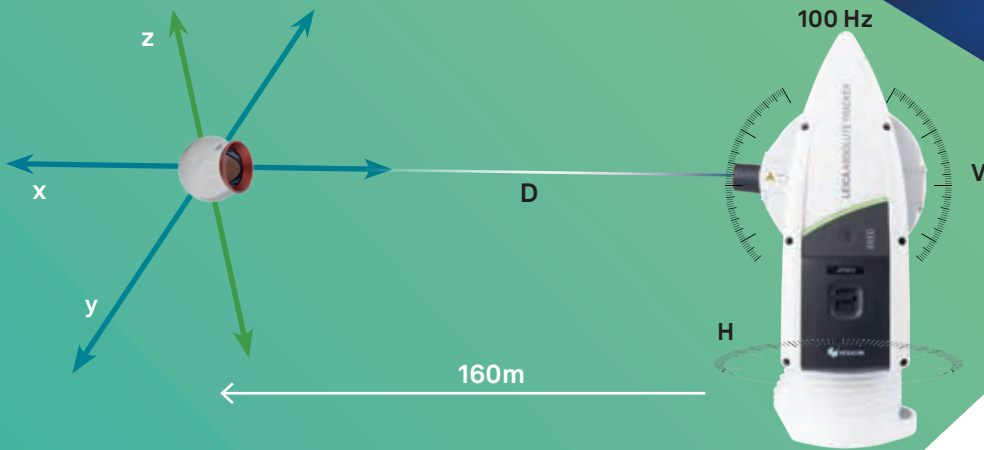

D: distance  
V: vertical angle  
H: horizontal angle

# Leica Absolute Tracker AT500

## Portable

**All-weather performance:** IP54-rated protection and a working temperature range of -15 to +50°C make it reliable in extreme conditions.

**Compact design:** Integrated controller, battery power and wireless functionality for maximum portability and flexibility.

## Easy and accurate

**User-friendly features:** One-button operation and WiFi connectivity simplify setup and use.

**Flexible orientation:** Works in any position, including upside down, for diverse applications.

**High precision:** Achieves 3D position accuracy down to 10 microns for precise measurements.

## Unmatched range and scale

**Made for large structures:** Measures up to 320 metres in diameter, ideal for inspecting large structures like ships and antennas.

**Consistent accuracy:** Ensures accuracy from right in front of the tracker up to 160 metres, even in open-area inspections.

## Seamless

**Efficient relocation** within the same coordinate system, using 3D reflector measurement ensures continuity without recalibration, saving time on expansive measurement tasks

**Compatible** with entry-level B-Probe<sup>plus</sup>

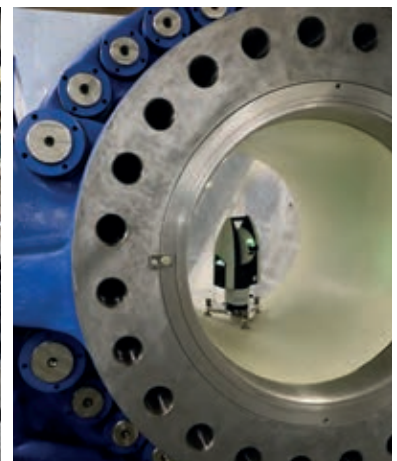

Absolute Tracker range

# B-Probe<sup>plus</sup>

## Entry-level probing

The B-Probe<sup>plus</sup> is a wireless solution designed for probing parts with open tolerances, such as welded structures or casted components.

Paired with the Leica Absolute Tracker AT500, it provides accurate measurements of points not visible to the tracker up to 12 metres away, making it an ideal tool for a wide range of inspection tasks.

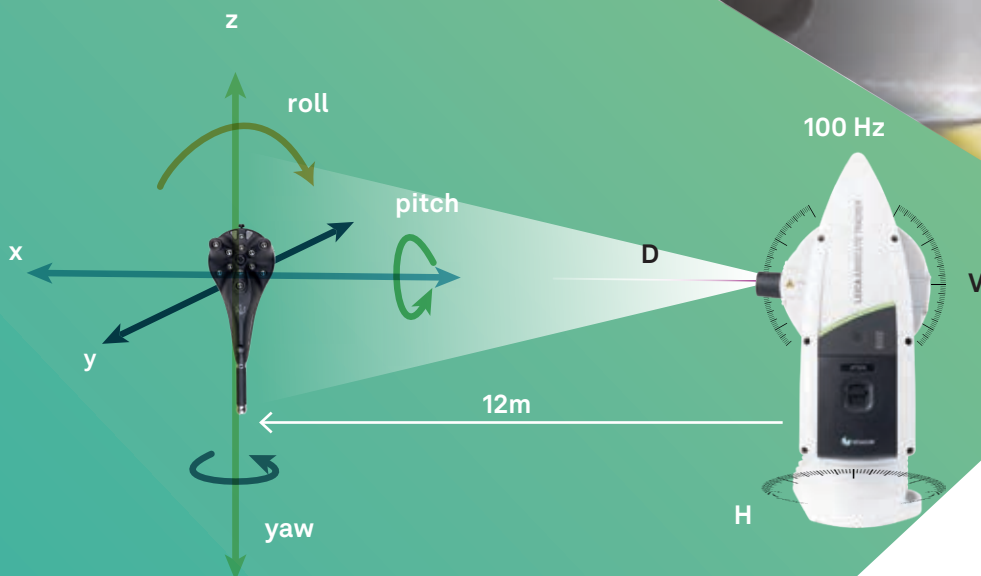
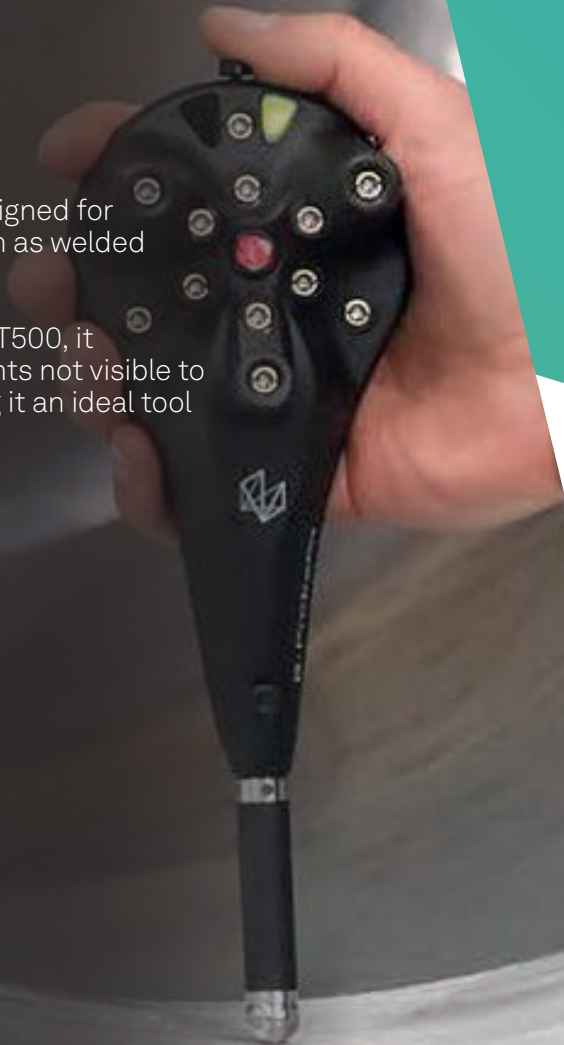

D: distance  
V: vertical angle  
H: horizontal angle

# B-Probe<sup>plus</sup>

## Simplify your workflow

The B-Probe<sup>plus</sup> allows rapid measurement of hidden points, simplifying workflows and improving efficiency for various inspection tasks.

**Stable probing:** Wireless, remote-controlled operation with a 12-metre range.

**Fast setup:** Click-and-measure functionality reduces preparation time.

## Operate with ease

Designed for easy operation, the B-Probe<sup>plus</sup> requires minimal training.

**Live feedback:** Provides real-time updates on probe and tracker alignment.

**Versatile styli:** Styli of various sizes and tip shapes available, including punch tools.

## Depend on durability

The B-Probe<sup>plus</sup> combines robust construction with portability for effortless handling in demanding environments.

**Extended battery life:** Provides up to 6 hours of continuous use.

**Durable build:** lightweight carbon fibre design ensures operator comfort during extended measurements.

## Rely on accuracy

Built for compliance with industry standards, ensuring precise and reliable measurements for critical applications.

**ISO 10360-10 Certification:** Meets stringent specifications for high-accuracy measurements.

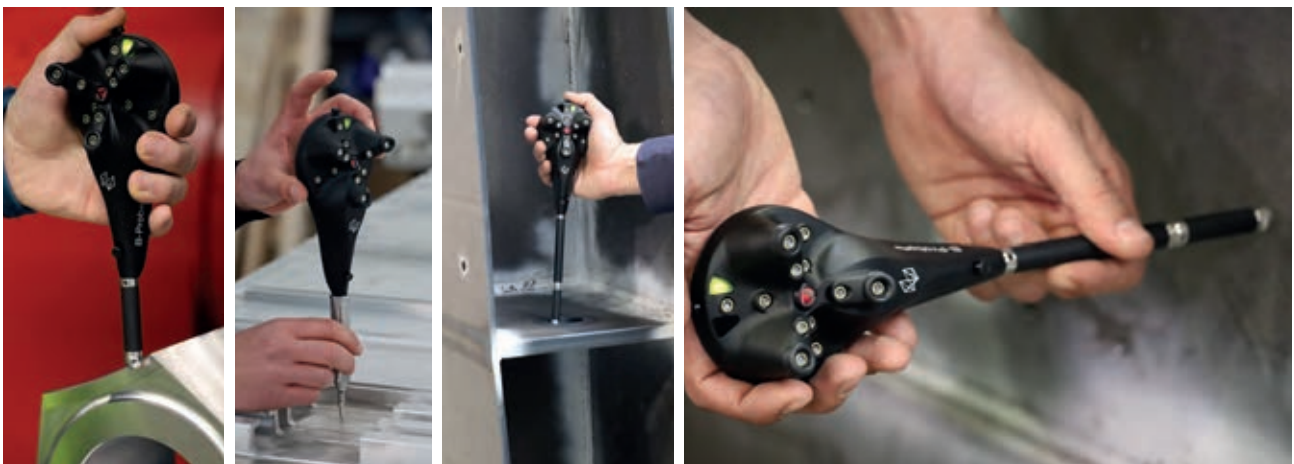

Absolute Tracker range

# Leica Absolute Tracker AT800

## High-accuracy direct scanning tracker

The AT800 redefines large-scale inspection and scanning by delivering unmatched accuracy, speed and seamless workflow integration.

It excels at fast, precise scanning for complex features and fine details, from up to 40 metres away.

With selective scanning capabilities and high-definition cameras, it provides user-defined inspections with uniform point distribution, perfect for demanding applications in aerospace, automotive, energy and beyond.

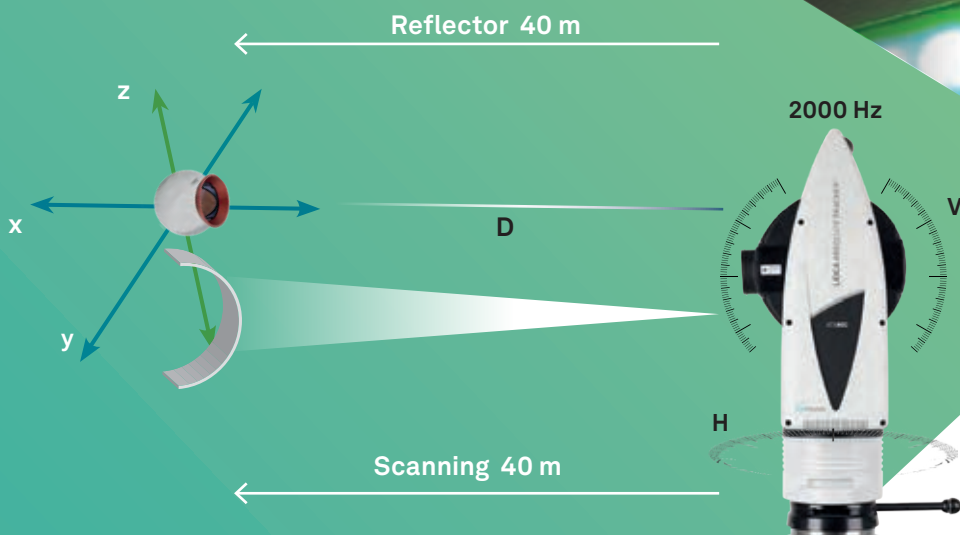

# Leica Absolute Tracker ATS800

## Precise

**Detailed inspections:** Captures fine details with precise scans, enabling accurate inspection of edges, fasteners and intricate features directly on production lines.

**Selective scanning:** True selective scanning allows user-defined areas with uniform point distribution for consistent results.

**TruePoint technology:** Pinpoints the true centre of each measurement, keeping them highly accurate to reduce rework. TruePoint saves you time and costs.

## Scalable

**Distance scanning:** Ideal for inspecting sizable assemblies and industrial environments with the ability to scan large objects from afar.

**Enhanced safety:** Remote operation and scanning at a distance protects workers in busy or hazardous settings.

## Efficient

**Simplified workflow integration:** Compatible with reflectors for metrology-assisted assembly and inspection.

**Faster alignment:** PowerLock technology automatically locks onto reflectors, reducing setup time and accelerating inspections.

**AI-powered feature recognition:** Automatically identifies and measures features like holes and edges with FeatureDetect, speeding up your inspections while maintaining consistency.

## Portable

**Durable and lightweight:** Compact design with integrated WiFi, battery power and IP54 protection ensures reliability and versatility across environments.

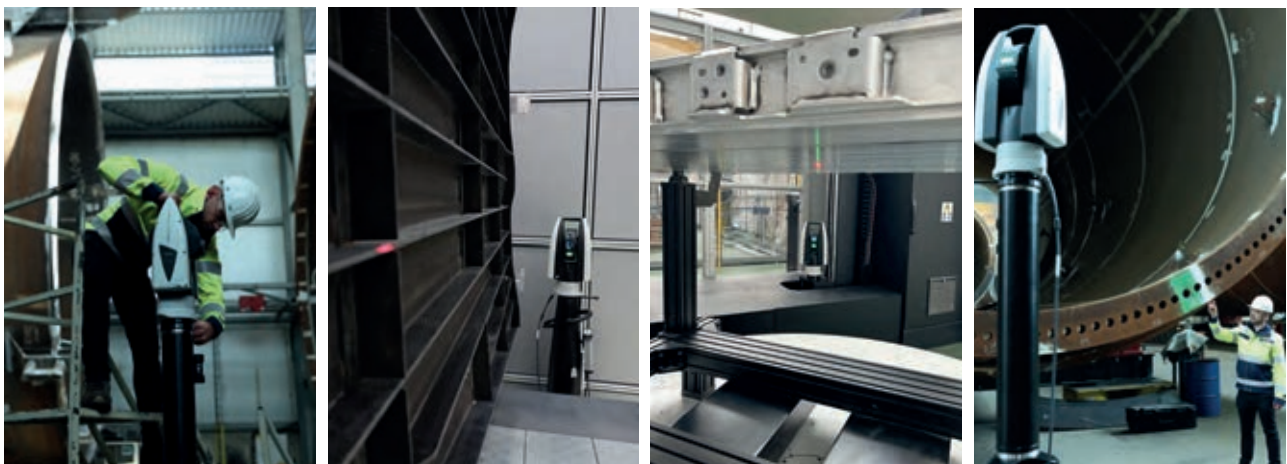

Absolute Tracker range

# Leica Absolute Tracker ATS600

The direct scanning tracker for large surfaces

The Leica Absolute Tracker ATS600 revolutionises big-scale measurement for large surfaces by bridging the gap between point-by-point measurement and advanced laser scanning.

Delivering three times the accuracy of leading terrestrial scanners, it integrates seamlessly into established metrology workflows, providing immediate on-site results without post-processing.

Powered by high-definition surveying technology, the ATS600's Enhanced Wave Form Digitiser uses time-of-flight and phase-shift measurement for fast, long-distance accuracy—with no target required. Enabling refined metrological accuracy and range noise within 80 microns ( $1\sigma$ ). The ATS600 offers unparalleled precision for non-contact measurements.

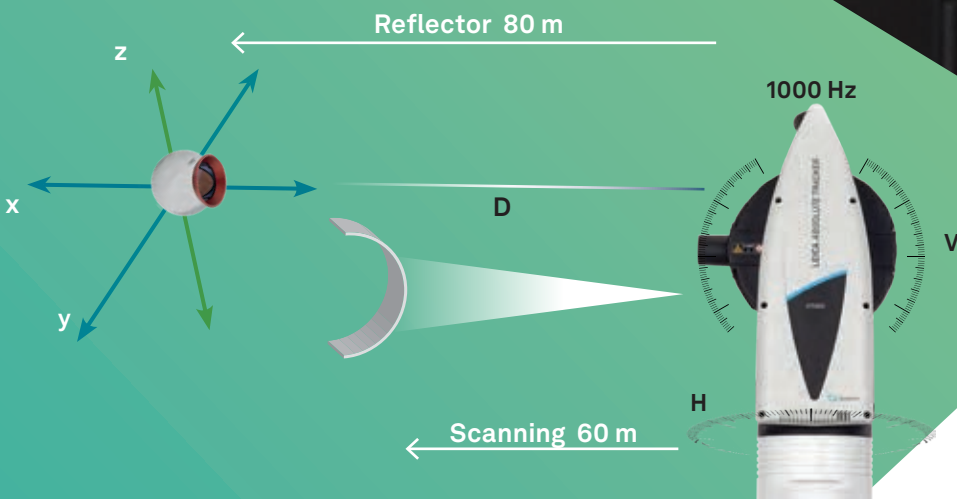

D: distance  
V: vertical angle  
H: horizontal angle

# ATS600

## Fast

**Customised scanning speed:** Tailor data point density to your needs—from quick checks at 10 seconds per square metre to high-accuracy at 135 seconds per square metre.

**Streamlined process:** One-user operation ensures easy target identification and efficient result processing.

## Scalable

**Long-distance accuracy:** Achieve metrology-grade precision to within 300 microns at distances of up to 60 metres.

**Selective scanning:** Define specific areas to scan with CAD data or the Overview Camera, creating a uniform grid of points that represent the entire surface.

## Integrated

**Seamless integration:** Collect data at up to 1000 Hertz and deliver it directly to metrology software for instant analysis.

## Easy

**Effortless setup and use:** One-user operation ensures easy target identification and efficient result processing.

**Advanced productivity features:** Includes uniform grid scanning, high-resolution zoom, panorama imaging and Line and Ring Scan profiles.

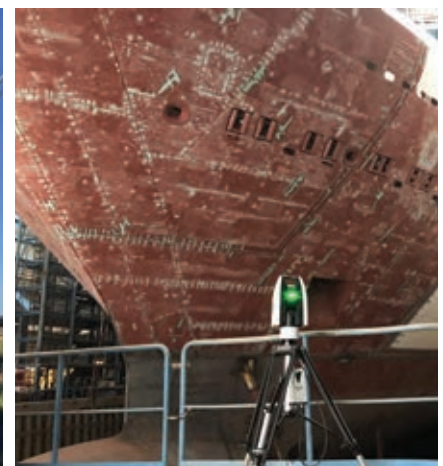

Absolute Tracker range

# Automation

## Automated part inspection with the ATS800 and ATS600

The ATS600 and ATS800 bring unique automation-ready solutions to transform your workflows.

Whereas the AT960 automated scanning systems excel in terms of speed and full surface coverage, the ATS600 and ATS800 offer a simpler configuration with improved flexibility and safety.

These trackers seamlessly integrate with AMRs, robotic systems and Industry 4.0 platforms. They support you to simplify operations, enhance safety with remote capabilities and provide scalable automation for demanding manufacturing environments.



## Connectivity

The ATS600 and ATS800 are battery powered and have wireless functionality for easy automation and integration, without complex cabling and additional connection boxes.

# Automation

## Rails and turn tables

Mounting the ATS800 or ATS600 on a rail streamlines and automates the inspection process by enabling controlled, linear movement across a defined axis.

When combined with a turntable, the solution offers complete 360° part coverage, enabling inspection of complex geometries and hard-to-reach areas in a single workflow. This ensures precise and repeatable measurements over large or elongated parts without manual intervention.



## Autonomous mobile inspection

The ATS800 and ATS600 can be mounted on Autonomous Mobile Robot (AMR) offers a flexible autonomous inspection solution.

Scanning from a distance avoids risk of collision ensuring safety for the part and the instrument. Wireless data transfer offers freedom of movement.



## Robotic scanning cell

For applications requiring even greater flexibility, the ATS800 can be mounted on a robotic arm. This can be useful when an application requires the inspection of intricate parts and hidden areas that would fall outside the line-of-sight of a fixed-position tracker.

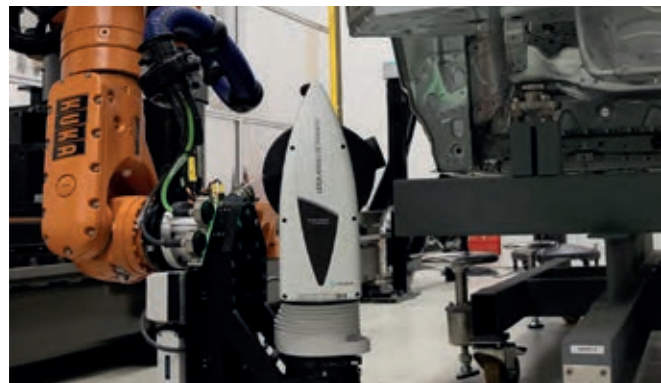

## Fixed installations with simultaneous scanning

Direct scanning laser trackers enable fixed installations to be fully automated. Multiple trackers can simultaneously scan from different angles, reducing inspection time and removing the need for high investment robot and rail systems for suited applications.



## Add-ons

# Accessories

## Make the most of your laser tracker

Hexagon's comprehensive range of innovative accessories support practical and efficient use of Absolute Trackers, delivering added functionality and improved productivity across all applications.

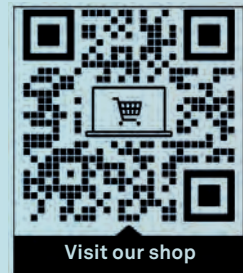

### Probing styli



### Wall mounts



### Tripods and stands



### Measurement cart



### Leveling unit



# Reflectors

## A retroreflector for every application

With automatic target location, real-time architecture, and instant beam recovery, Hexagon's retroreflector range delivers fast, accurate and consistent measurements for any application.

### Ultra-wide-angle options



#### **Super CatEye Reflector** *Ultra-wide acceptance angle*

The Super CatEye Reflector offers a unique ultra-wide laser acceptance angle, designed to deliver productivity improvement without the need for high-cost investment in additional complex technical devices.



#### **Super CatEye Reference Target** *Mountable ultra-wide-angle measurement*

A variant of the Super CatEye Reflector, the Super CatEye Reference Target offers the same ultra-wide acceptance angle while being directly surface mountable, either magnetically or through its 6-mm M4 centre bore hole, making it ideal for machine calibration tasks.

### Precision options



#### **Red Ring Reflector** *Ultimate 3D accuracy*

The absolute standard for accurate 3D measurement, Red Ring Reflectors are precision corner-cube reflectors with a hardened steel surface, available in three sizes (1.5", 7/8" and 0.5").

### Fixed measurement options



#### **Fixed Installation Reflector** *Mountable and reliable measurement*

For applications demanding the same measurements be made repeatedly, a fully mountable retroreflector that can be fixed in place to provide a robust and cost effective solution

### Resilient reflectors



#### **Break Resistant Reflector** *Shop-floor resilience*

Designed for challenging industrial environments, Break Resistant Reflectors offer a greater degree of robust construction.



#### **Drop Resistant Reflector** *Shop-floor resilience*

Designed for challenging industrial environments, Drop Resistant Reflectors offer a greater degree of robust construction.

### Entry-level reflectors



#### **Green Ring Reflector** *Entry-level reflectors*

Price attractive alternative with a reduced centring accuracy. Ideal for applications with wider tolerances.



#### **Tooling Ball Reflector** *Basic reflector measurement*

For those situations where the ability to make many measurements is more important than having the highest degree of accuracy, the Tooling Ball Reflector is a basic entry-level retroreflector suitable for a wide range of industrial applications.

Software

# Digital platform solutions

Get the most value from your metrology technology

## Nexus

Centralise manufacturing within an open and integrated digital reality platform

Nexus connects people, technology and data to drive faster innovation in manufacturing. By breaking down silos, it enables seamless collaboration across disciplines, allowing you to put your data to work.

ne:us BY  HEXAGON

### Nexus delivers:

- ✓ **Speed:** Accelerate time to market with smooth collaboration and automated data sharing
- ✓ **Efficiency:** Save time and costs with better visibility and faster decisions
- ✓ **Productivity:** Boost output with quicker feedback loops throughout the product life cycle
- ✓ **Optimal Data Sharing:** Share only the data needed to solve specific challenges

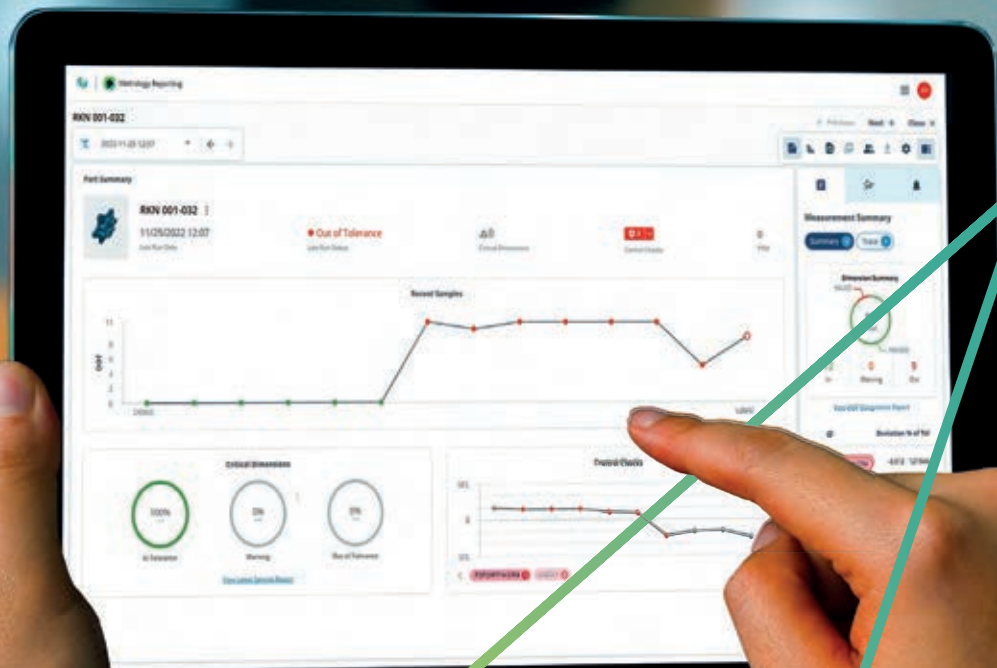



## Compatible metrology software

Get seamless integration with all leading metrology platforms

Absolute Trackers are fully compatible with all major metrology digital platforms, ensuring smooth integration into your existing workflows.

Use the tools you trust.

- Hexagon platform
- Third-party platform

## Metrology Asset Manager

Track your Absolute Tracker from anywhere

Keep track of your Absolute Trackers health and performance from anywhere in the world. The Metrology Asset Manager provides accurate, reliable remote monitoring and analysis, giving you peace of mind as you work in the field.

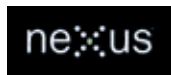

Visit our shop

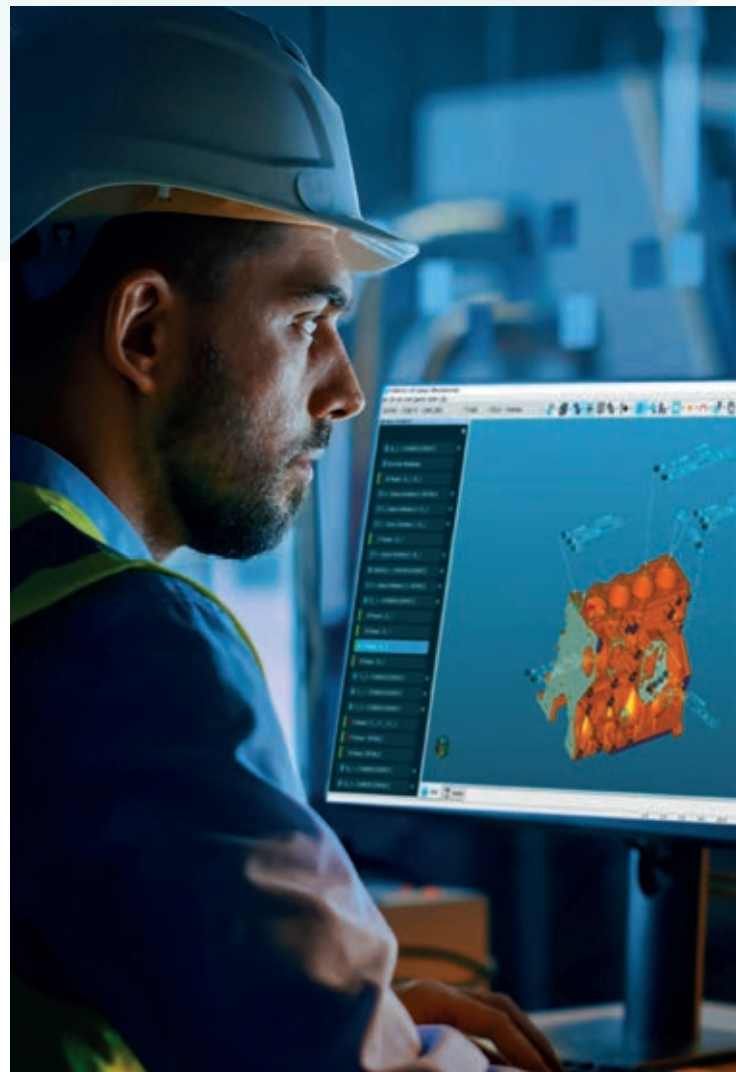

# Which Absolute Tracker is right for you?

## 6DoF and 3D Absolute Trackers

### AT960

A high-performance 6DoF laser tracker for dynamic, precise measurements in both manual and automated setups. It's ideal for complex assembly and robotic workflows.



- Dynamic measurement up to 1000 Hz
- 7DoF real-time robotic control with T-Mac compatibility
- Ultra-portable design for use in diverse environments

### AS1-XL scanner

A large-area scanner for fast, wide-range surface measurements.



### AS1 scanner

A high-speed 3D scanner for accurate surface and feature digitisation.



### AT930

A high-speed 3D laser tracker for reflector-based measurements, designed for large-volume inspection and fast alignment in harsh industrial environments.



- Fast dynamic measurement with 1000 Hz output
- PowerLock for uninterrupted measurement alignment
- IP54 certification for harsh environments

### Leica T-Probe

A wireless probing tool for hard-to-reach, hidden measurement points.



### T-Mac

A 6DoF tracking sensor for automated robotic and machine applications.



## Accessories and Software

### Reflectors

Essential tools for achieving precise, line-of-sight measurements using laser tracker technology.



### Probing styli

Customisable stylus tips designed to meet a variety of probing and measurement requirements.



### Wall mounts, tripods, stands and measurement carts

Reliable setups that provide stability and mobility for laser tracker operations.



## Direct Scanning Absolute Trackers

### AT500

The simplest and most portable laser tracker. It's been created for outdoor and large-scale reflector-based measurements in rugged or remote environments.



- IP54-rated protection for rugged conditions
- Completely wireless operation with hot-swappable batteries
- Fast 6DoF probing up to 12m with B-Probe Plus

### ATS800

An advanced direct-scanning tracker for precision manufacturing workflows. The ATS800 is ideal for measuring complex geometries and large surfaces safely and efficiently.



- High-accuracy scanning up to 40m with TruePoint
- AI-powered FeatureDetect for automated inspections
- Automation-ready with AMR and robotic system integration

### ATS600

A direct-scanning tracker for contactless, large-scale inspections that's ideal for inspecting large parts and surfaces with minimal operator effort.



- Reflectorless scanning up to 60m with 80-micron accuracy
- User-configurable scanning grid to balance speed and detail
- Integrated Overview Camera for precise scan area definition

### Leica B-Probe<sup>plus</sup>

A compact, wireless probe for portable measuring.



### Nexus

A centralised platform that connects systems and data for seamless Industry 4.0 integration.



### Metrology Asset Manager

A real-time monitoring tool that helps you optimise equipment performance and maintenance schedules.



### Compatible metrology software

Seamlessly integrate with popular metrology platforms to streamline workflows.





## Certifications

# ISO certifications

## The standards behind Absolute Tracker accuracy

To ensure our trackers deliver not just a high degree of accuracy but also proven and traceable results, we align with a selection of defined and trusted international standards

### ISO 10360-10

The accuracy specifications for measurement with our laser trackers are stated in accordance with the international ISO 10360-10 standard for laser tracker measurements.

### ASTM E3125-17

The direct scanning performance of ATS600 systems is specified in line with the ASMT E3125-17 standard that is used to test the performance of large-volume 3D scanners.

### ISO 17025

To ensure delivery in line with our published accuracies, every one of our Absolute Tracker systems and sensors is calibrated at an ISO 17025 accredited laboratory staffed by skilled engineers and outfitted with a wide range of high-end technical equipment and diagnostic tools.

## The tests that guarantee accuracy

We use three main tests to check the accuracy of our various tracker systems, in line with the ISO 10360-10 standard for laser trackers and the ASMT E3125-17 standard for large-volume 3D scanners.

### Location test

Also known as a two-face test. Comparison of measurements to a stationary target by rotating the horizontal encoder 180 degrees and elevating the vertical encoder to lock onto the target. This test is designed to quickly reveal geometry imperfections.

This test is performed using reflectors in line with ISO 10360-10 and also using direct scanning in line with ASMT E3125-17.

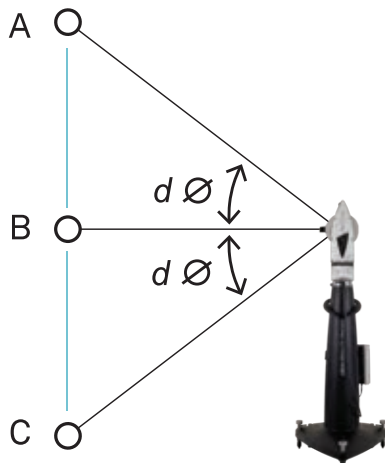

### Length test

Measurement of a standardised and calibrated scale bar at predefined distances. This test is designed to show how accurately the tracker measures in a specified volume.

This test is performed using reflectors according to ISO 10360-10. For direct scanning, it's in accordance to ASTM E3125-17.

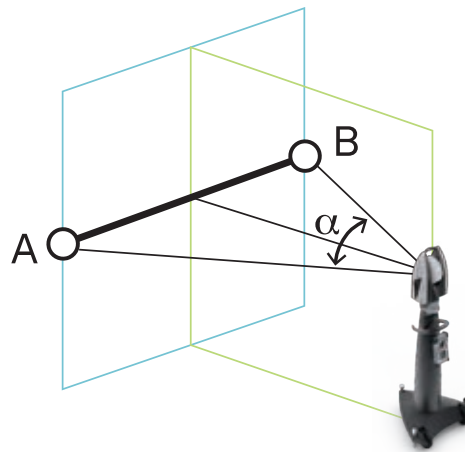

### Ranging test

Comparison of measurements to a series of calibrated stationary targets at increasing distance from the tracker. This test is designed to verify the performance of the distance meter.

This test is performed using reflectors in line with ISO 10360-10.

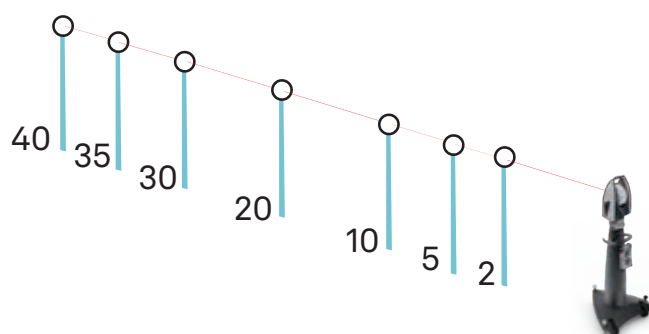

### P<sub>SIZE</sub>

The P<sub>SIZE</sub> value is the maximum permissible error for measuring the diameter of a sphere. It therefore signifies the accuracy of feature measurements.



# Specifications

See the data of the Absolute Tracker range

## Measurement ranges

Tracker model	3D	6DoF
AT960-XR	0 to 80 m	1.2 to 30 m
AT960-LR	0 to 80 m	1.2 to 20 m
AT960-MR	0 to 20 m	1.2 to 10 m
AT960-SR	0 to 6 m	1.2 to 5 m
AT930	0 to 80 m	-
ATS800	0.6 to 40 m	-
ATS600	0.8 to 80 m 1.5 to 60 m (direct scanning)	-
AT500	0.8 to 160 m	1.6 to 12 m

## Trackers compared

	AT960   AT930	AT500	ATS800	ATS600	
General information	Tracker size   weight	477 x 258 x 238 mm   14.2 kg	477 x 261 x 238 mm   13.6 kg	477 x 258 x 238 mm   14.2 kg	
	Controller size   weight	249 x 148 x 59 mm   1.65 kg	Built-in controller   0 kg	249 x 148 x 59 mm   1.65 kg	249 x 148 x 59 mm   1.65 kg
	Laser class	Class 2 Laser Product in accordance with IEC 60825-1 Second Edition (2014-05)	Class 2 Laser Product in accordance with IEC 60825-1 Second Edition (2014-05)	Class 1 Laser Product in accordance with IEC 60825-1 Second Edition (2014-05)	Class 2 Laser Product in accordance with IEC 60825-1 Second Edition (2014-05)
	Overview Camera	5MP   10-degree FOV	5MP   10-degree FOV	12MP   10-degree FOV	5MP   10-degree FOV
	PowerLock range	60 m	80 m	40 m	60 m
	ISO 17025 certified	✓	✓	✓	✓
	Warranty	2 years   extension possible with Customer Care Packages	2 years   extension possible with Customer Care Packages	2 years   extension possible with Customer Care Packages	2 years   extension possible with Customer Care Packages
Environmental	Operating temperature	0°C to +40°C	-15°C to +50°C	0°C to +40°C	0°C to +40°C
	Relative humidity	max. 95% non-condensing	max. 95% non-condensing	max. 95% non-condensing	max. 95% non-condensing
	Operating elevation	-700 m to +5500 m	-700 m to +5500 m	-700 m to +5500 m	-700 m to +5500 m
	Dust   water	IP54	IP54	IP54	IP54
Interface	Cable	Cat6	Cat6	Cat6	Cat6
	Wireless	WLAN (IEEE 802.11n)	WLAN (IEEE 802.11n)	WLAN (IEEE 802.11n)	WLAN (IEEE 802.11n)
Power management	Battery type	Lithium-ion battery   swappable	Lithium-ion battery   integrated and swappable	Lithium-ion battery   swappable	Lithium-ion battery   swappable
	Typical battery runtime (single charge)	6 hours	6 hours	6 hours	6 hours
	Data output	1000 Hz	100 Hz	2000 Hz	1000 Hz
	Mains	AC power supply	AC power supply	AC power supply	AC power supply

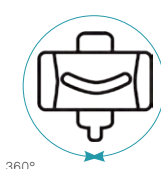
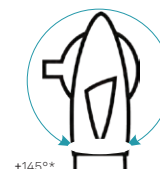
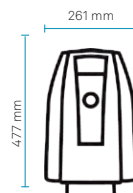
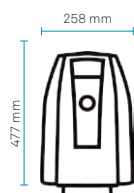

\* For all Absolute Tracker models, except for the ATS800, whose vertical coverage is ±140°.

### Angular performance (location test)

Measurement distance	AT960   AT930   AT500   ATS800   ATS600	
	Typical	MPE
5 m	±23 µm	±45 µm
10 m	±38 µm	±75 µm
20 m	±68 µm	±135 µm

### Length measurement (length test)

Measurement distance	AT960   930   500		ATS800		ATS600	
	Typical	MPE	Typical	MPE	Typical	MPE
5 m	±32 µm	±64 µm	±32 µm	±64 µm	±40 µm	±81 µm
10 m	±53 µm	±106 µm	±53 µm	±106 µm	±53 µm	±106 µm
20 m	±96 µm	±191 µm	±96 µm	±191 µm	±96 µm	±191 µm

### Distance measurement (ranging test)

Measurement distance	AT960   AT930 (IFM)		AT930   AT960   AT500 (ADM)		ATS800		ATS600	
	Typical	MPE	Typical	MPE	Typical	MPE	Typical	MPE
1.5 to 5 m	±1 µm	±1 µm	±7 µm	±14 µm	±12 µm	±24 µm	±71 µm	±142 µm
1.5 to 10 m	±1 µm	±3 µm			±22 µm	±44 µm	±72 µm	±143 µm
1.5 to 20 m	±3 µm	±5 µm			±42 µm	±84 µm	±76 µm	±152 µm
1.5 to 30 m	±4 µm	±8 µm			±62 µm	±124 µm	±83 µm	±165 µm
1.5 to 40 m	±5 µm	±11 µm			±82 µm	±164 µm	±92 µm	±183 µm
1.5 to 50 m	±8 µm	±15 µm			-	-	±102 µm	±203 µm

### Scanning accuracies

Sensor	AS1	AS1-XL
$P_{SIZE}^1$	±60 µm	±240 µm
Length measurement <sup>2</sup>	±50 µm	±150 µm

### 3D scanner specifications

	AS1	AS1-XL
Scanner type	Blue laser line scanner	Blue laser line scanner
Accuracy	0.013 mm <sup>3</sup>	0.134 mm <sup>3</sup>
Point acquisition rate	1.2 million points/s	1.2 million points/s
Points per frame	max. 4000	max. 4000
Frame rate	max. 300 Hz	max. 300 Hz
Line width (mid)	150 mm	600 mm
Standoff	165 ± 50 mm	700 ± 300 mm
Minimum point spacing	0.027 mm <sup>4</sup>	0.08 mm <sup>4</sup>
System scanning certification	yes	yes
Laser class	2	2
Protection rating	IP54	IP54
Operating temperature	0-40°C	0-40°C
Weight	0.43 kg	0.46 kg

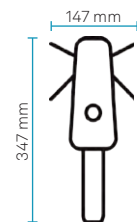

Technical details

# Specifications

See the data of the Absolute Tracker range

## Probing accuracy

Sensor	Leica T-Probe	B-Probe <sup>plus</sup>	1.5" Red Ring Reflector
P <sub>SIZE</sub> <sup>1</sup>	± 50 µm	± 100 µm	± 20 µm
Length measurement <sup>5</sup>	± 57 µm	± 150 µm	± 38 µm

## Probes compared

	T-Probe	B-Probe <sup>plus</sup>
Size   weight	310 x 129 x 70 mm   0.65 kg	230 x 80 x 54 mm   0.14 kg
Cable-free operation	✓	✓
Multiple programmable buttons	✓	-
Instant visibility feedback	✓	-
Automatic stylus recognition	✓	-
Multiple stylus mounting positions	✓	-
Acoustic feedback	✓	-
Battery type	1 x Lithium-ion   swappable	2 x AAA (NiMH)   swappable
Typical battery runtime (single charge)	> 5 hours	> 6 hours

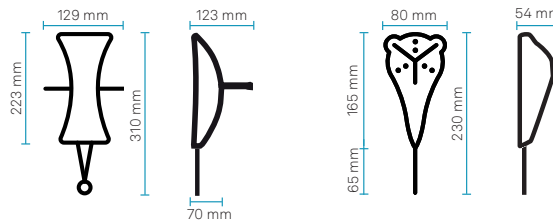

## Other accuracies

Absolute angular performance e <sub>r</sub> <sup>6</sup>	±15 µm + 6 µm/m
AIFM absolute distance performance	±0.5 µm/m
Dynamic lock-on	±10 µm
Inclination sensor	±1.0 arcsec
Orient to gravity U <sub>z</sub>	±15 µm + 8 µm/m
Timestamp accuracy	< 5 µsec

## T-Mac models compared

	T-Mac Basic TMC30	T-Mac Frame TMC30-F	T-Mac Multiface TMC30-M
Size	270 x 125 x 140 mm	231 x 199 x 110 mm	327 x 209 x 203 mm
Weight	1.48 kg	1.11 kg	2.9 kg

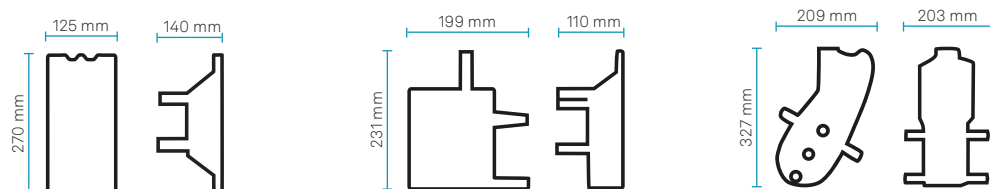

# ATS800/ATS600 scanning specifications

Accuracy	ATS800	ATS600
Range noise	< 40 $\mu\text{m}$	< 80 $\mu\text{m}$ <sup>7</sup>
Absolute accuracy	$\pm 21 \mu\text{m} + 8.5 \mu\text{m}/\text{m}$	< $\pm 300 \mu\text{m}$ <sup>8</sup>
Angular performance $E_{\text{two-face,MPE}}$	$\pm 15 \mu\text{m} + 6 \mu\text{m}/\text{m}$	$\pm 50 \mu\text{m} + 10 \mu\text{m}/\text{m}$ <sup>9</sup>
Length measurement $E_{\text{distance,MPE}}$	$\pm 21 \mu\text{m} + 8.5 \mu\text{m}/\text{m}$	$\pm 150 \mu\text{m}$ <sup>9</sup>

Speed	ATS800	ATS600
Scan rate	2000 Hz	1000 Hz

All accuracies stated as Maximum Permissible Error (MPE). Typical values half of MPE.

<sup>1</sup>  $P_{\text{Size,Sphere,t} \times 25, \text{ODR:LT,MPE}}$  measured at 2 m according to ISO 10360-10: 2021 Annex G

<sup>2</sup> Up to 30 m

<sup>3</sup>  $P_{\text{Form,Sph,t} \times 25, \text{ODS,MPE}}$

<sup>4</sup> Near range

<sup>5</sup> Accuracy at 2 m measurement distance; for other measurement distances:

Length measurement T-Probe  $E_{\text{Vol:ODR:LT,MPE}}$  :  $\pm 42 \mu\text{m} + 7.7 \mu\text{m}/\text{m}$

Length measurement B-Probe<sup>Plus</sup>  $E_{\text{Vol:ODR:LT,MPE}}$  :  $\pm 137 \mu\text{m} + 6.3 \mu\text{m}/\text{m}$

Length measurement 1.5° RRR  $E_{\text{Vol:ODR:LT,MPE}}$  :  $\pm 21 + 8.5 \mu\text{m}/\text{m}$

<sup>6</sup> Angular Performance Transverse  $e_t$  according to ISO 10360-10

<sup>7</sup> Standard deviation (1 $\sigma$ ) of a best-fit plane (78% albedo), distance 1.5 to 30 m, standard measurement mode, target aligned

<sup>8</sup> Maximum deviation (MPE) of the absolute position of a plane (78% Albedo), 1.5 to 30 m, 0 to  $\pm 45^\circ$  incidence angle

<sup>9</sup> In accordance with ASTM E3125-17 Tables 2, 3 and 4

<sup>10</sup> At default point-to-point and line-to-line distance, measurement distance 10 m

## Patent notice

Products described in this brochure are covered by the following US patents.

### AT930

US 9,377,296 B2 | US 10,054,422 B2 | US 9,638,519 B2 | US 9,612,331 B2 | US 10,036,811 B2 | US 8,279,430 B2 | US 9,366,531 B2 | US 7,609,387 B2 | US 8,305,563 B2

### AT960

US 9,377,296 B2 | US 10,054,422 B2 | US 9,401,024 B2 | US 9,638,519 B2 | US 9,612,331 B2 | US 9,720,087 B2 | US 10,036,811 B2 | US 8,031,331 B2 | US 8,279,430 B2 | US 9,366,531 B2 | US 7,609,387 B2 | US 8,305,563 B2

### AT960-XR

US 9,377,296 B2 | US 10,054,422 B2 | US 9,401,024 B2 | US 9,638,519 B2 | US 9,612,331 B2 | US 9,720,087 B2 | US 10,036,811 B2 | US 8,031,331 B2 | US 9,864,062 B2 | US 8,279,430 B2 | US 9,366,531 B2 | US 7,609,387 B2 | US 8,305,563 B2

### AT500

US 9,377,296 B2 | US 9,322,654 B2 | US 10,036,811 B2 | US 8,279,430 B2 | US 8,772,719 B2 | US 9,366,531 B2 | US 8,305,563 B2 | US RE47,430 E | US 9,341,500 B2 | US 9,810,964 B2 | US 9,405,007 B2

### AS1 and AS1-XL

US 10,302,745 B2 | US 10,330,466 B2 | US 10,323,927 B2

### B-Probe<sup>Plus</sup>

US 9,816,813 B2

### ATS800

US 7,619,719 | US 8,279,430 | US 8,896,843 | US 9,341,500 | US 9,366,531 | US 9,377,296 | US 9,612,331 | US 10,048,379 | US 10,054,422 | US 810,634,788 | US 10,444,361

# Service and support

## Discover your options

### World-class products to rely on

Drawing on decades of research and development experience, laser tracker technology from Hexagon's Manufacturing Intelligence division is built on a long history of outperforming technological innovation. Deriving quality from experience to drive productivity is what keeps Hexagon in front and able to deliver first-class solutions for industries around the world.

That's why every major laser tracker product in this brochure comes with a 24-month factory warranty as standard, as well as a guaranteed 10 years of serviceability through official Hexagon service channels.

### World-class support delivered locally

The international presence of Hexagon guarantees comprehensive aftersales support and services across the globe. With the largest dedicated service team of any metrology equipment manufacturer and an emphasis on locally delivered solutions, Hexagon is unmatched from service, repair, certification and calibration through operator training and software maintenance and upgrades.

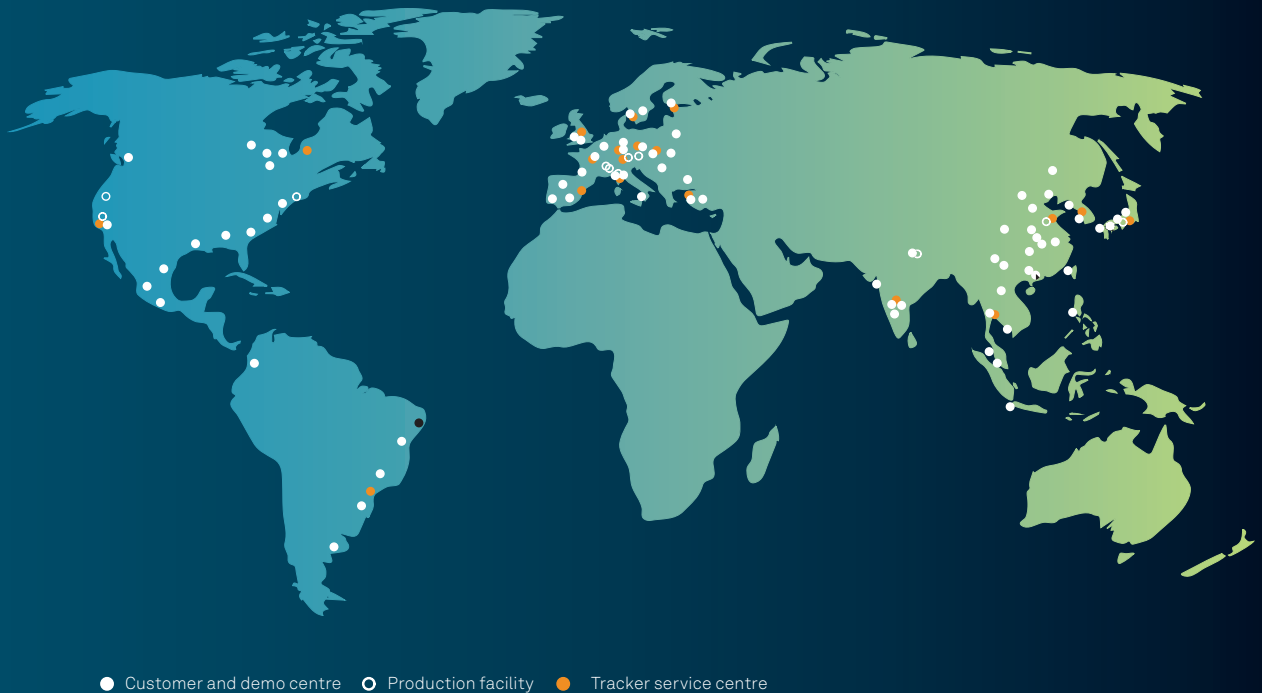



# Service and support

## Discover your options

### World-class service made simple

Hexagon offers a wide range of support services extending well beyond the point of purchase. Delivered by experienced and skilled engineers at ISO-certified laboratories, local Hexagon Precision Centres or even on-site to minimise downtime, our after-sales portfolio is the most complete on the market.

- Maintenance and warranty plans that ensure equipment availability
- Trouble-free usage and minimal downtime
- Preferred hotline access at no additional cost
- Access to professional advice whenever needed

### Customer Care Packages

Owners of the Hexagon laser tracker products featured in this brochure also have the opportunity to invest in a Customer Care Package designed to ensure equipment remains in top condition and can be relied on for accurate measurement results throughout a lifetime of use.

Customer Care Packages include a selection of the following benefits, depending on the tier chosen.

	Platinum	Gold	Silver	Bronze
Planned annual service	✓	✓	✓	✓
Customer hardware support	✓	✓	✓	✓
Annual maintenance and recertification	✓	✓	✓	
Remote connected assistance	✓	✓		
Repair parts and labour	✓			
Customised local benefits	✓	✓	✓	✓

For complete details of the benefits of each level of Customer Care Package, please contact a local Hexagon representative.

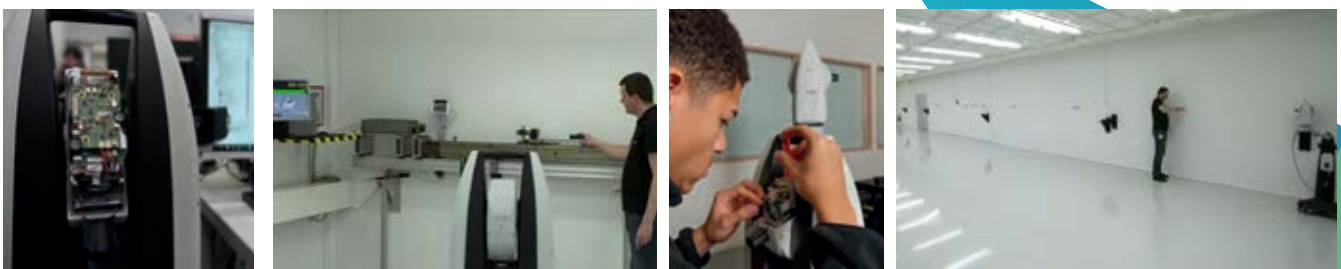





Hexagon is a global leader in digital reality solutions, combining sensor, software and autonomous technologies. We are putting data to work to boost efficiency, productivity, quality and safety across industrial, manufacturing, infrastructure, public sector and mobility applications.

Our technologies are shaping production and people-related ecosystems to become increasingly connected and autonomous—ensuring a scalable, sustainable future.

Hexagon's Manufacturing Intelligence division provides solutions that use data from design and engineering, production and metrology to make manufacturing smarter.

Learn more about

Hexagon (Nasdaq Stockholm: HEXA B)

at [hexagon.com](https://www.hexagon.com) and follow us [@HexagonAB](https://twitter.com/HexagonAB)